

PLAN SHOWING THE PROPOSED GROUND FLOOR BUILDING AT PLOT NO:1B, SURVEY NO:142/3B OF

MAHASAKTHI COLONY, SEMBAKKAM VILLAGE, TAMBARAM TALUK, KANCHEEPURAM DISTRICT.

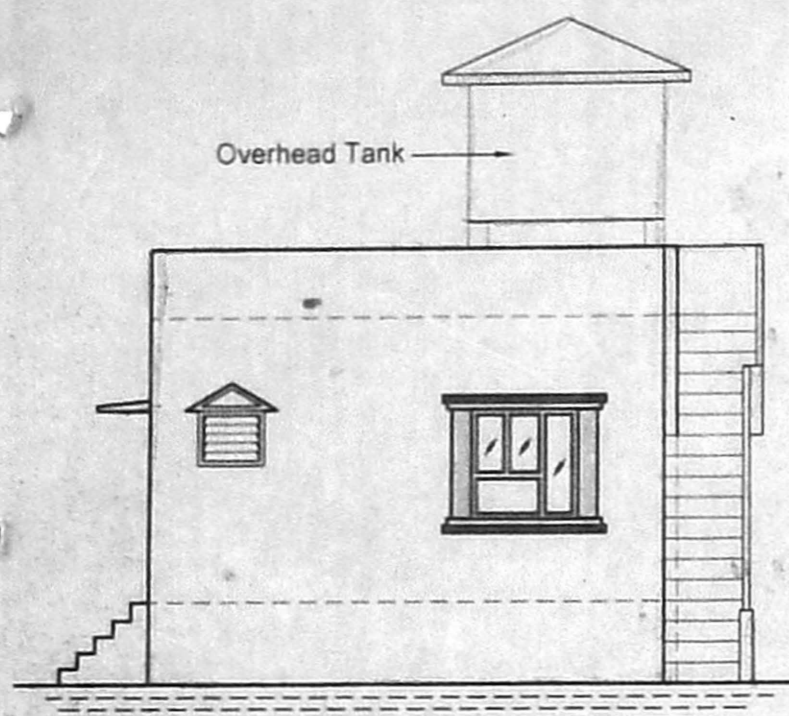

Front Elevation

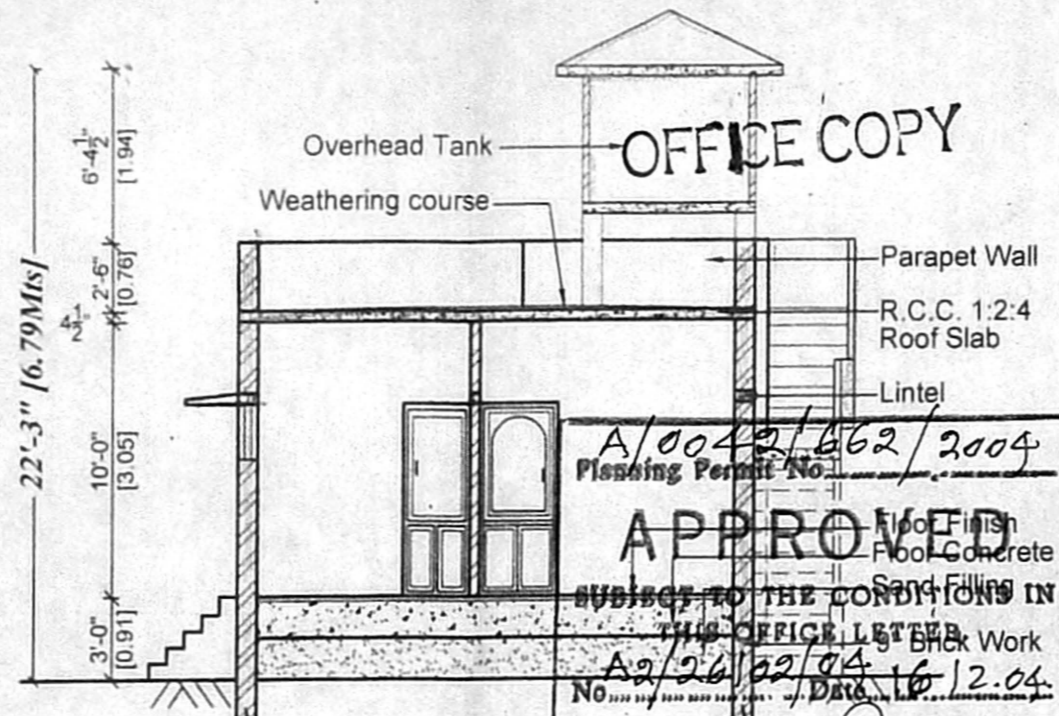
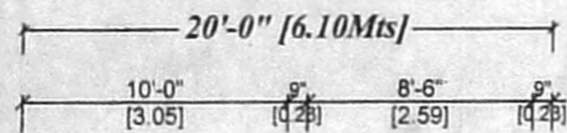

Cut Section on "AA"

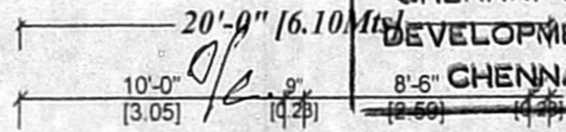

**APPROVED**  
 Planning Permit No. A/0042/662/2004  
 SUBJECT TO THE CONDITIONS IN THIS OFFICE LETTER  
 No. A2/26/02/04  
 Date: 16/12/04  
 FOR MEMBER SECRETARY  
 CHENNAI METROPOLITAN  
 DEVELOPMENT AUTHORITY  
 CHENNAI - 600 008.

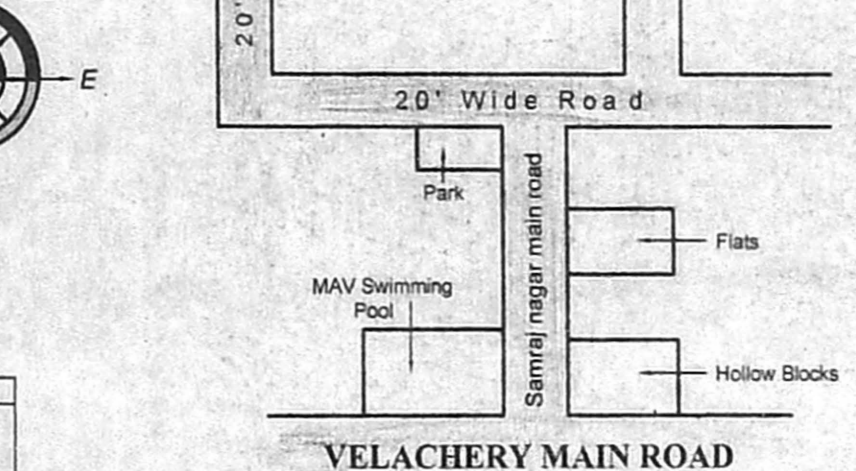
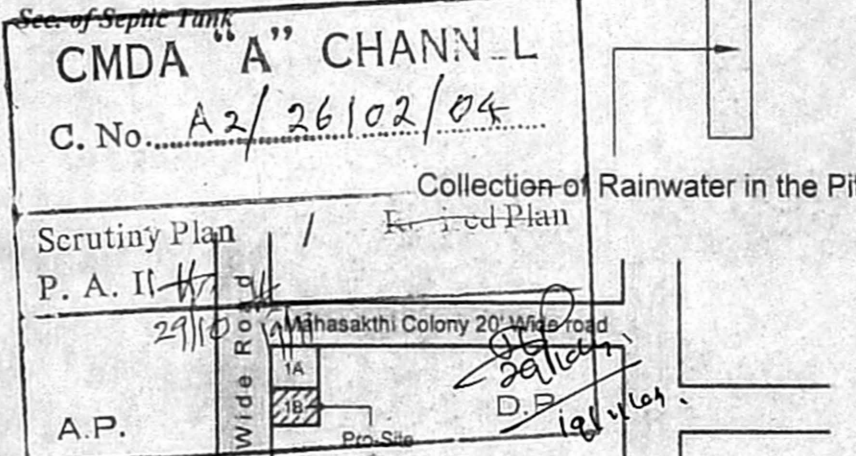
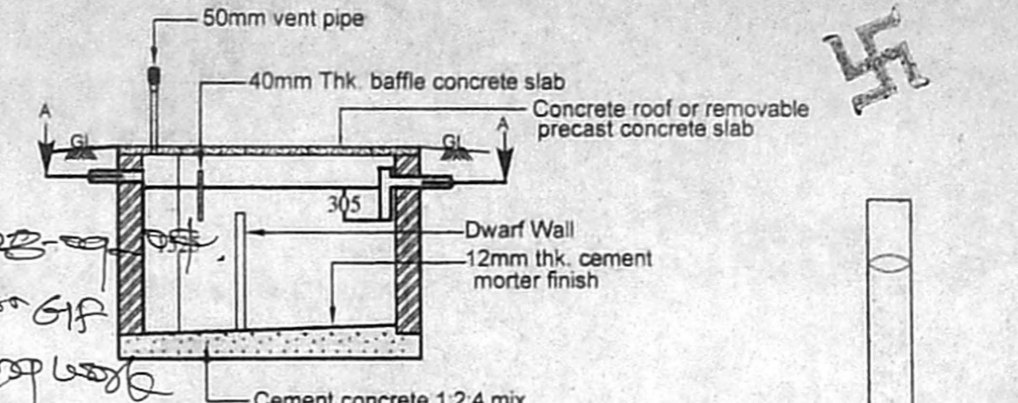
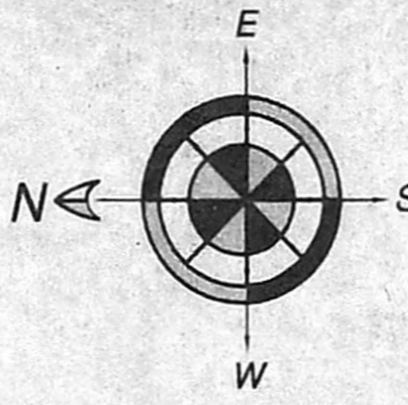
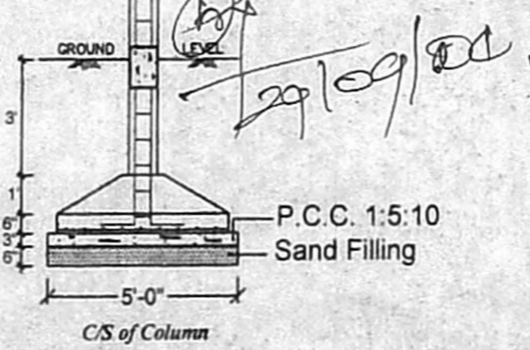
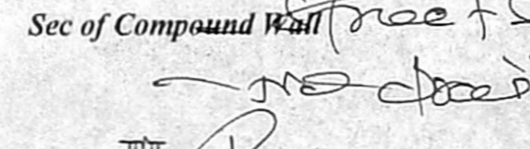
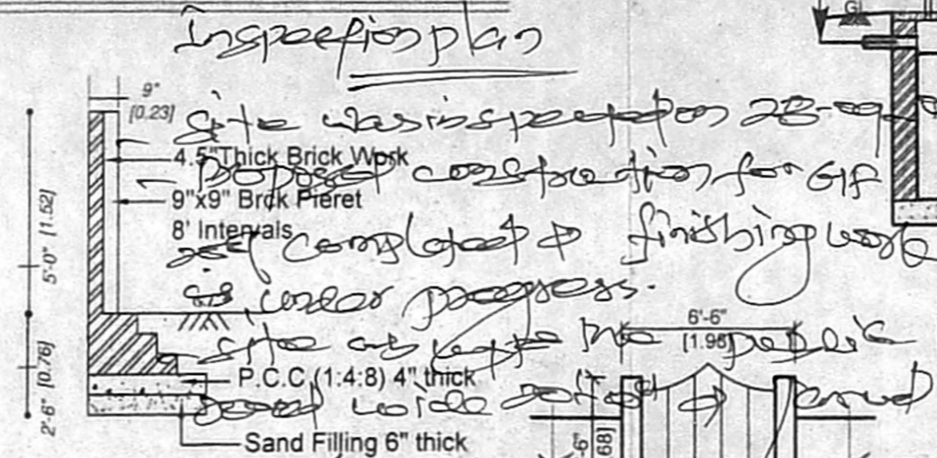

Key Plan (Not to Scale)

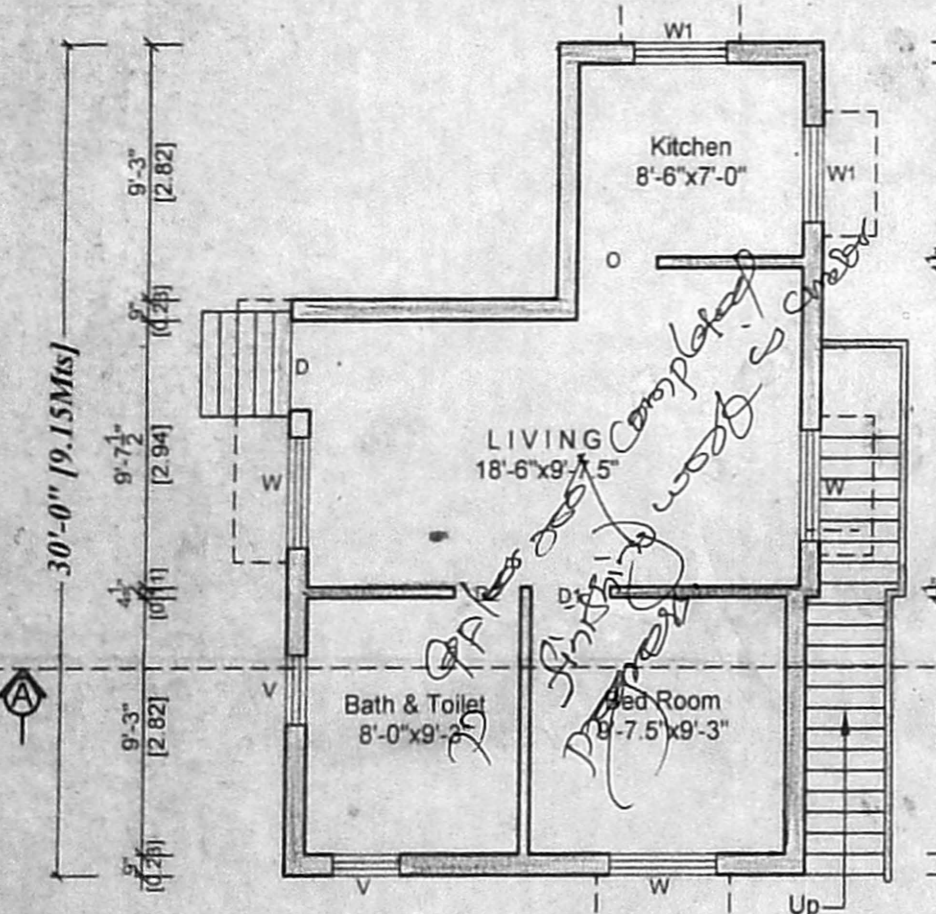

Ground Floor Plan

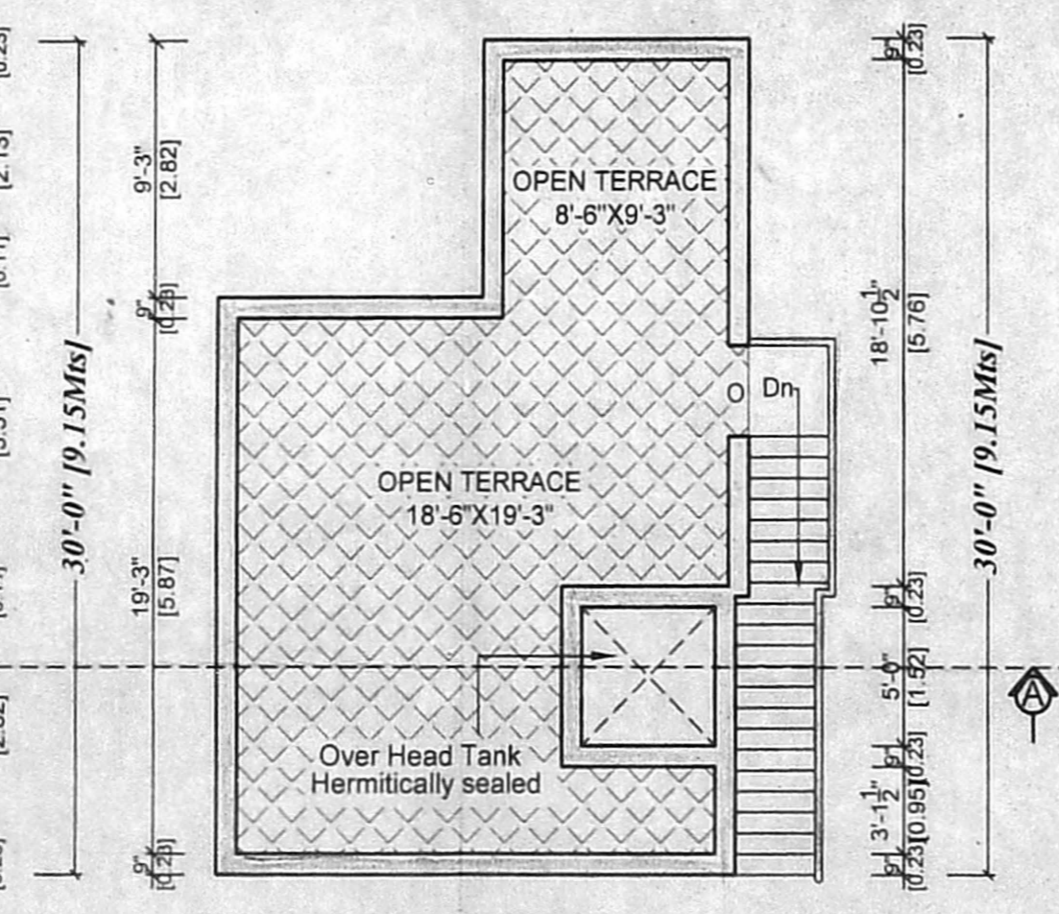
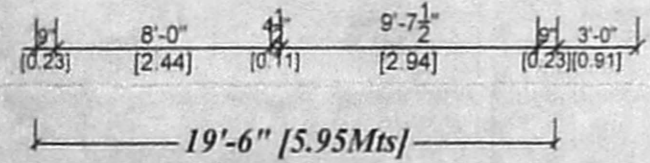

Terrace Floor Plan

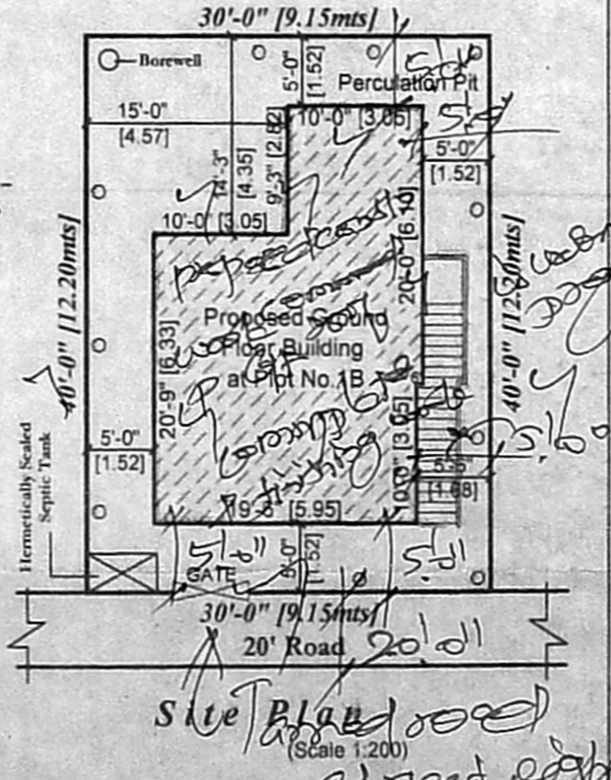
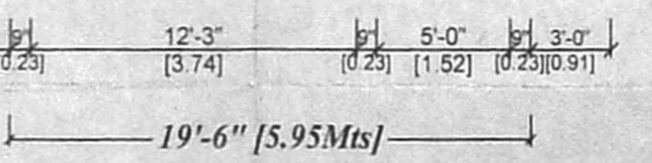

| JOINERY DETAILS |             |           |
|-----------------|-------------|-----------|
| D Door          | 3'6" x 7'0" | 1.0 x 2.1 |
| D1 Door         | 3'0" x 7'0" | 0.9 x 2.1 |
| D2 Door         | 2'6" x 7'0" | 0.7 x 2.1 |
| O Open          | 8'6" x 7'0" | 2.6 x 2.1 |
| W Window        | 4'0" x 4'0" | 1.2 x 1.2 |
| W1 Window       | 3'6" x 4'0" | 1.0 x 1.2 |
| V Ventilator    | 2'6" x 2'0" | 0.7 x 0.6 |

| LEGEND   |          | STAIRCASE DETAILS |          |
|----------|----------|-------------------|----------|
| PROPOSED | [Symbol] | RISE              | 15 cm    |
| ROAD     | [Symbol] | TREAD             | 25 cm    |
| BOUNDARY | [Symbol] | WIDTH             | 90 cm    |
| EXISTING | [Symbol] | WAIST SLAB        | 11.25 cm |

| AREA DETAILS      |         |        |
|-------------------|---------|--------|
| PLOT EXTENT       | 1200.00 | 111.50 |
| GROUND FLOOR AREA | 500.00  | 46.45  |
| PLOT COVERAGE     | 42%     |        |
| F.S.I. ALLOWED    | 1.50    |        |
| F.S.I. ACHIEVED   | 0.42    |        |

**OWNER'S SIGNATURE:**

**LICENSED SURVEYOR:**  
 G. GNANAPRAKASAM, O.C. - AMI  
 LICENSED SURVEYOR  
 TAMBARAM MUNICIPALITY  
 NO. 8, THIRUVALLUVER ST,  
 METTA NAGAR, CHENNAI - 72

**LICENSED SURVEYOR:**

**OFF: 22293086 RES: 22275968**

**SRI MURUGAN DESIGNS**  
 286 VELACHERY MAIN ROAD  
 RAJAKILPAKKAM  
 CHENNAI - 73